

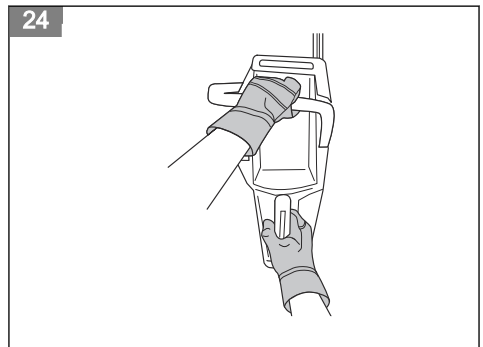

Husqvarna[®]

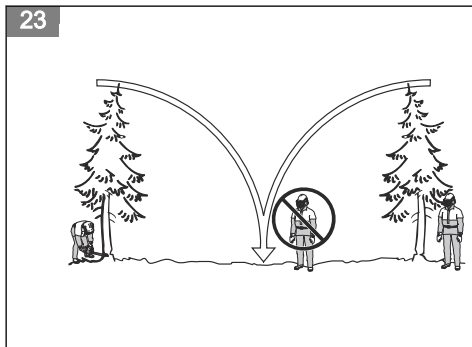

120e Mark II

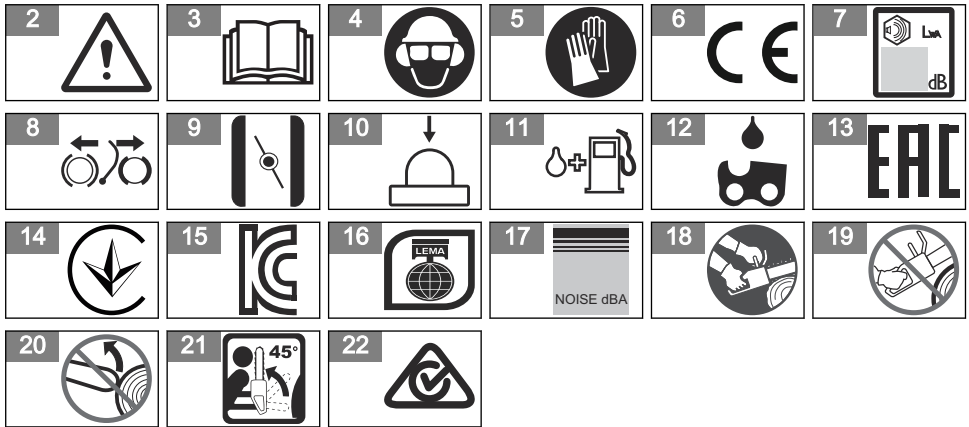
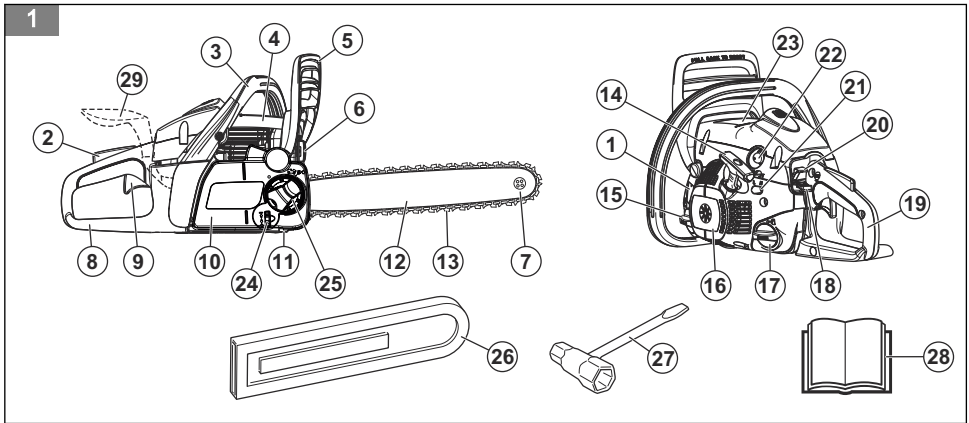

25



26

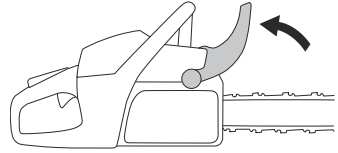

27

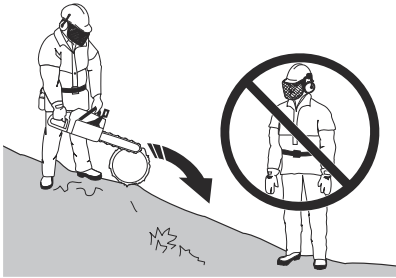

28

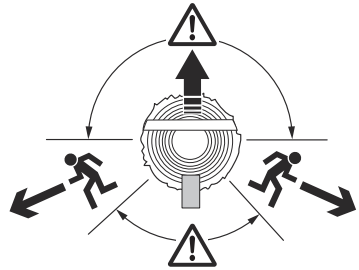

29



30



31



32

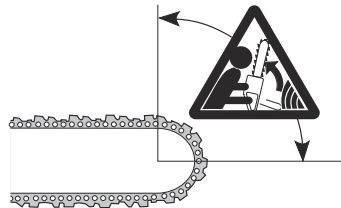

33

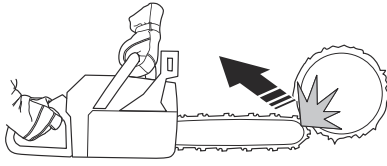

34

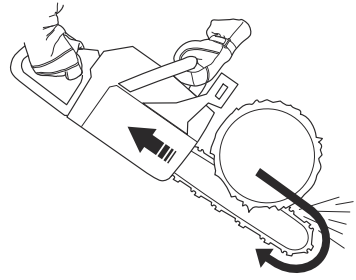

35

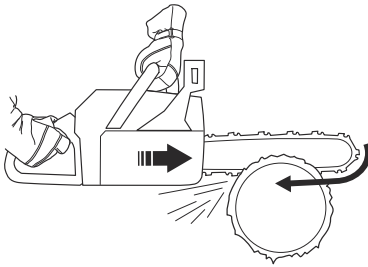

36

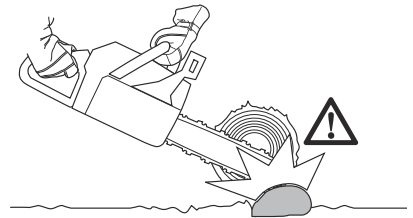

37



38

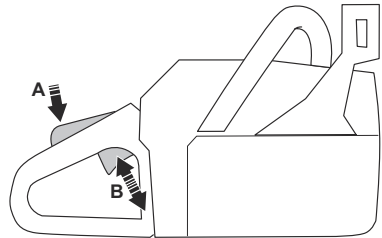

39

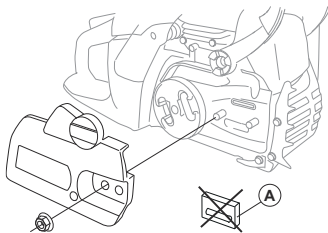

40

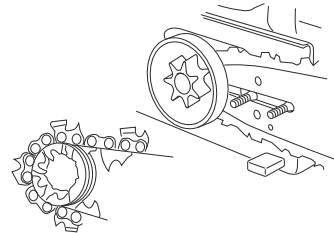

41

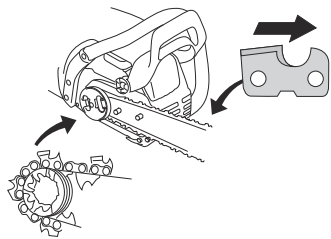

42

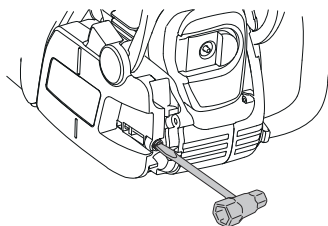

43

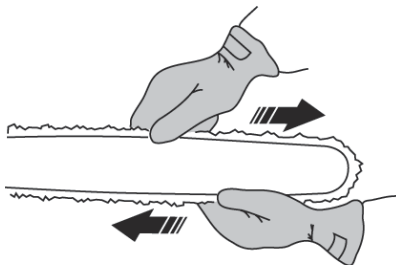

44

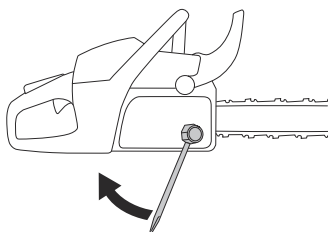

45

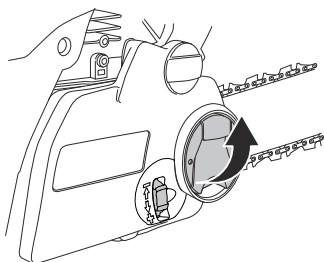

46

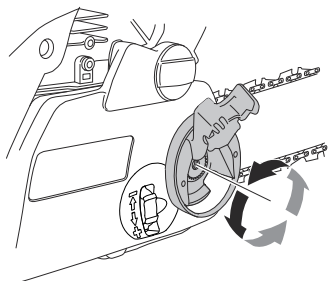

47

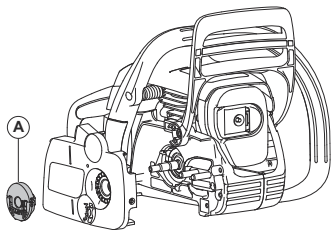

48

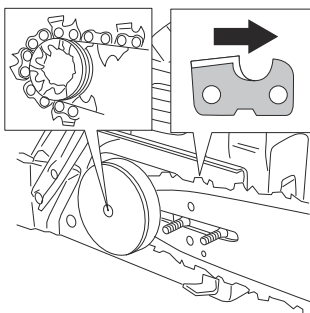

49

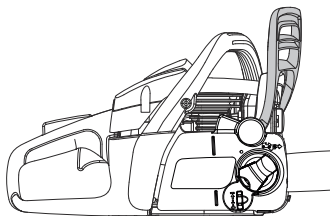

50

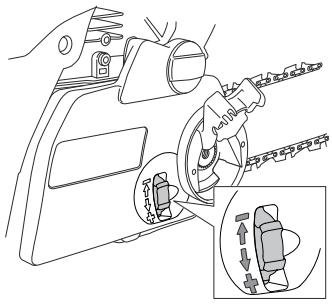

51

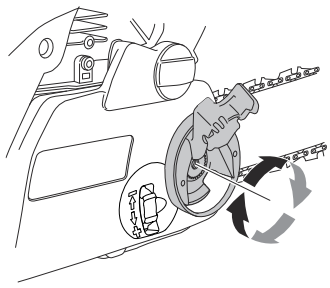

52

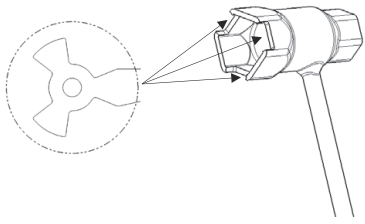

53

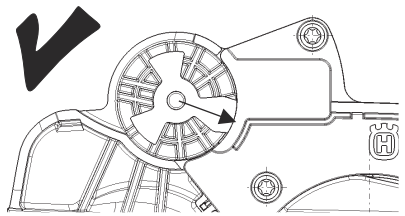

54

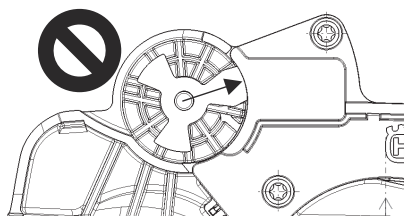

55

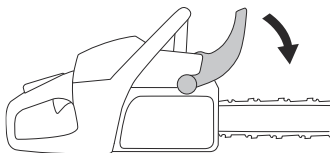

56

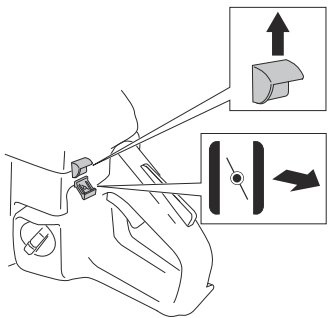

57

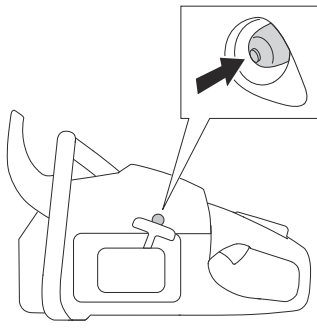

58



59

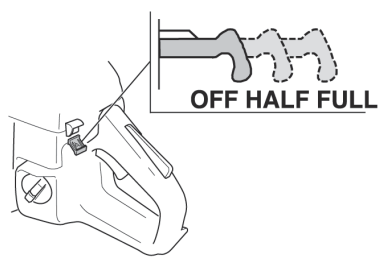

60

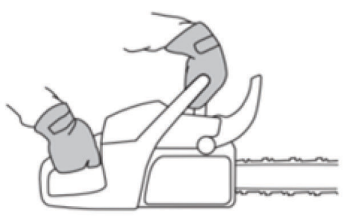

61

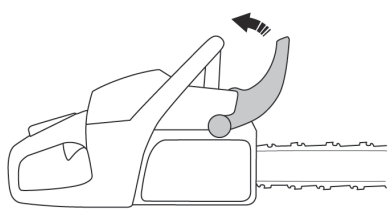

62

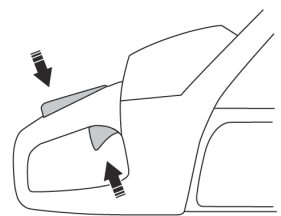

63

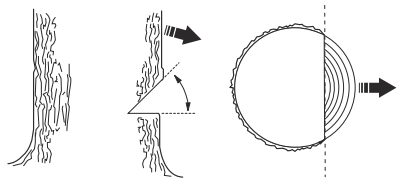

64

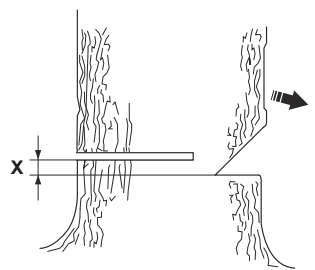

65

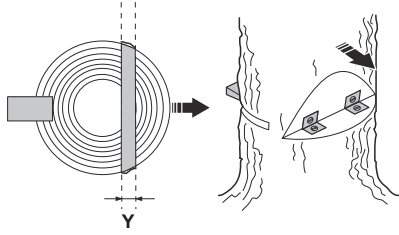

66

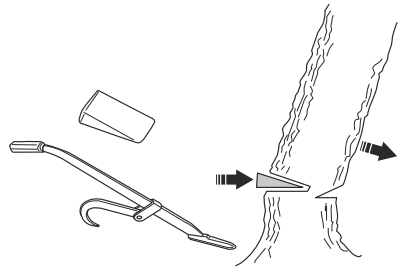

67

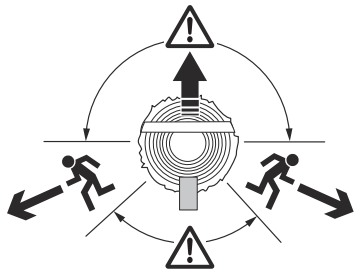

68

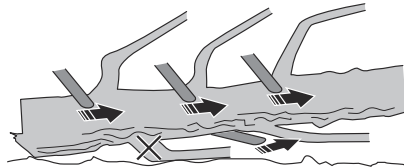

69

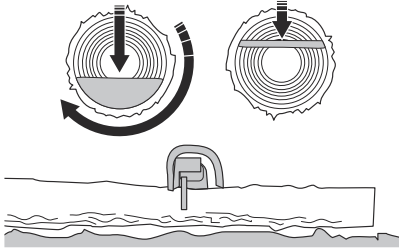

70

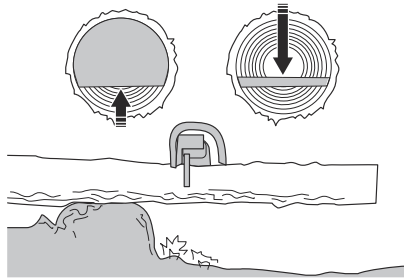

71

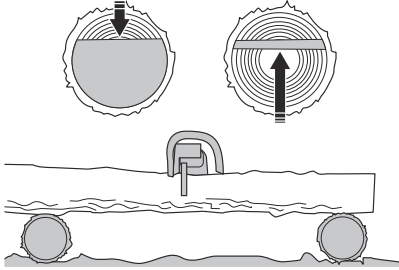

72

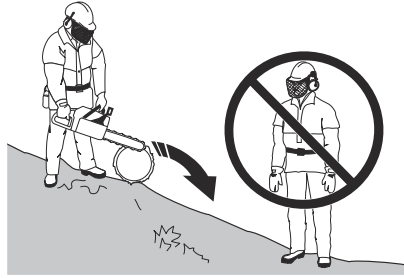

73

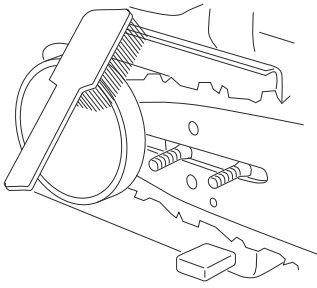

74

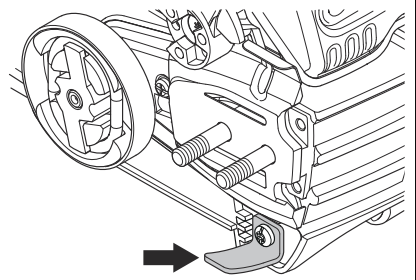

75

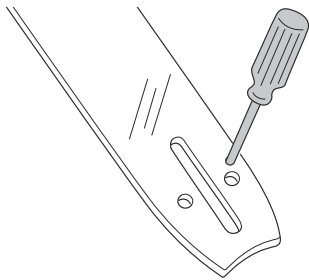

76

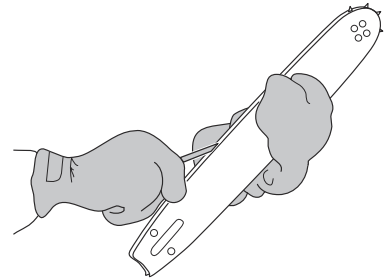

77

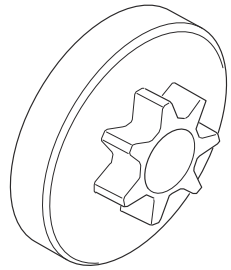

78

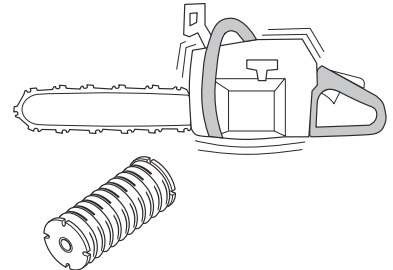

79

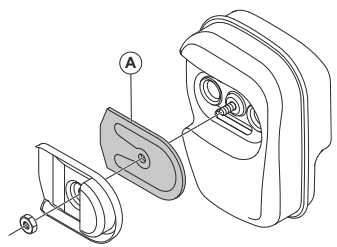

80

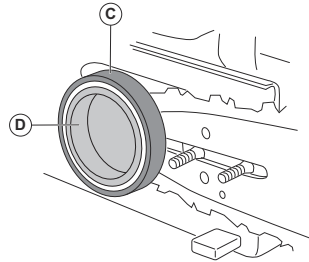

81

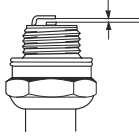

82

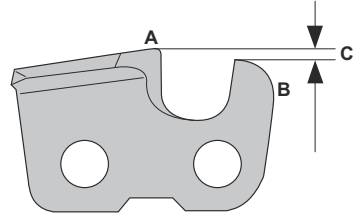

83

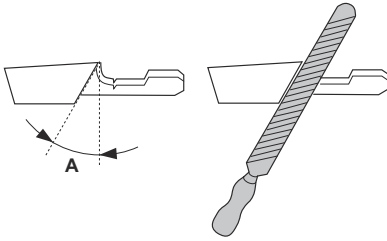

84

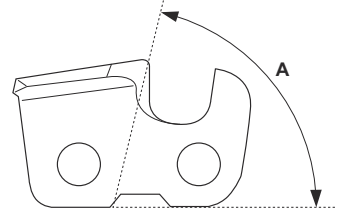

85

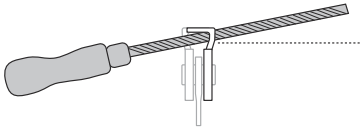

86

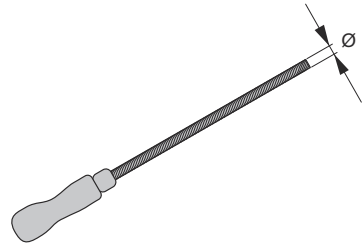

87

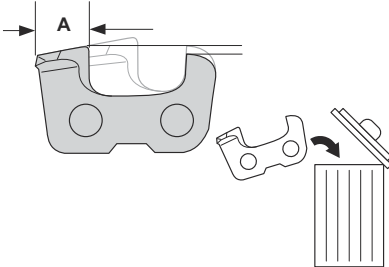

88

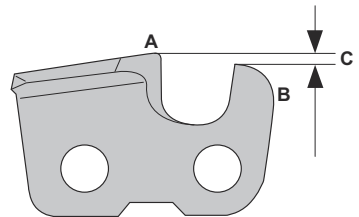

89

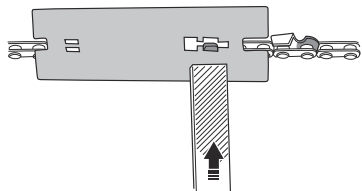

90

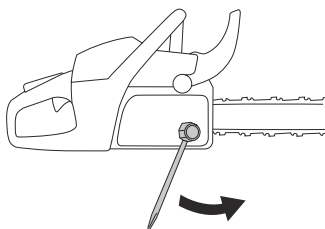

91

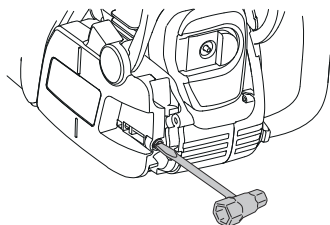

92

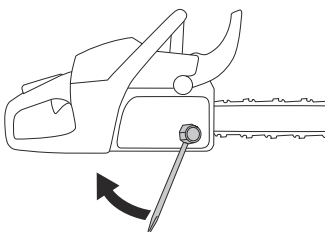

93

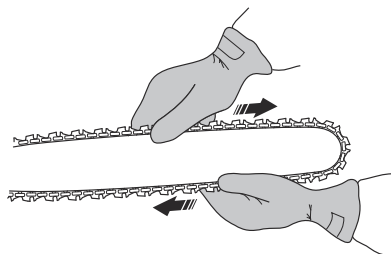

94

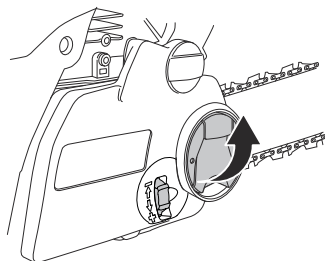

95

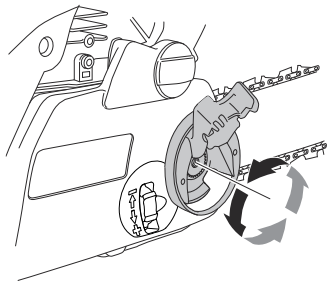

96

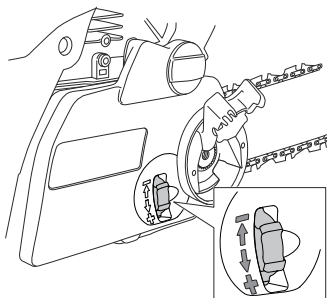

97

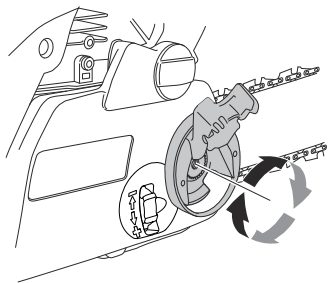

98

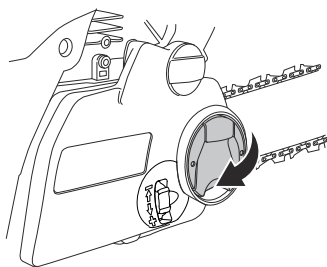

Contents

Introduction	13	Transportation	24
Safety	14	Storage	24
Assembly	17	Technical data	24
Operation	18	Accessories	25
Maintenance	21		

Introduction

Operator's manual

The initial language of this operator's manual is English. Operator's manuals in other languages are translations from English.

Overview

(Fig. 1)

- | | | |
|--|-----------|---|
| 1. Product and serial number plate | (Fig. 3) | Read this manual |
| 2. Trigger lockout | (Fig. 4) | Use approved head protection, hearing protection and eye protection |
| 3. Front handle | (Fig. 5) | Use approved protective gloves |
| 4. Cylinder cover | (Fig. 6) | The product agrees with the applicable EC Directives |
| 5. Chain brake and front hand guard | (Fig. 7) | Sound power level |
| 6. Muffler | (Fig. 8) | Chain brake, not engaged (left). Chain brake, engaged (right) |
| 7. Bar nose sprocket | (Fig. 9) | Choke control |
| 8. Right hand guard | (Fig. 10) | Air purge bulb |
| 9. Trigger | (Fig. 11) | Refuelling |
| 10. Sprocket cover | (Fig. 12) | Chain oil fill |
| 11. Chain catcher | (Fig. 13) | This product agrees with the applicable EAC directives |
| 12. Guide bar | (Fig. 14) | This product agrees with the applicable Ukraine directives |
| 13. Saw chain | (Fig. 15) | This product agrees with the applicable Korea directives |
| 14. Starter handle | (Fig. 16) | This product agrees with the applicable Japan directives |
| 15. Chain oil tank | (Fig. 17) | Noise level |
| 16. Starter | (Fig. 18) | Hold the product properly with both hands |
| 17. Fuel tank | (Fig. 19) | Do not use with one hand |
| 18. Choke control | (Fig. 20) | Avoid contact with nose of guide bar |
| 19. Rear handle | (Fig. 21) | Beware of kickback |
| 20. Stop switch | | |
| 21. Idle adjustment screw | | |
| 22. Primer bulb | | |
| 23. Information and warning decal | | |
| 24. Chain tensioner wheel | | |
| 25. Knob | | |
| 26. Guide-bar cover | | |
| 27. Combination tool | | |
| 28. Operator's manual | | |
| 29. Right-hand brake trigger (some models) | | |

Symbols on the product

(Fig. 2) Warning

(Fig. 22) This product agrees with the applicable Australia and New Zealand electromagnetic compatibility directives.

Note: Other symbols/decals on the product refer to certification requirements for other commercial areas.

Product liability

As referred to in the product liability laws, we are not liable for damages that our product causes if:

- the product is incorrectly repaired.
- the product is repaired with parts that are not from the manufacturer or not approved by the manufacturer.
- the product has an accessory that is not from the manufacturer or not approved by the manufacturer.
- the product is not repaired at an approved service center or by an approved authority.

Safety

Safety definitions

The definitions below give the level of severity for each signal word.



WARNING: Injury to persons.



CAUTION: Damage to the product.

Note: This information makes the product easier to use.

General safety instructions

- Use the product correctly. Injury or death is a possible result of incorrect use. Only use the product for the tasks found in this manual. Do not use the product for other tasks.
- Read, understand and obey the instructions in this manual. Obey the safety symbols and the safety instructions. If the operator does not obey the instructions and the symbols, injury, damage or death is a possible result.
- Do not discard this manual. Use the instructions to assemble, to operate and to keep your product in good condition. Use the instructions for correct installation of attachments and accessories. Only use approved attachments and accessories.
- Do not use a damaged product. Obey the maintenance schedule. Only do the maintenance work that you find an instruction about in this manual. An approved service center must do all other maintenance work.
- This manual cannot include all situations that can occur when you use the product. Be careful and use your common sense. Do not operate the product or do maintenance to the product if you are not sure about the situation. Speak to a product expert, your dealer, service agent or approved service center for information.
- Disconnect the spark plug cable before you assemble the product, put the product into storage or do maintenance.
- Do not use the product if it is changed from its initial specification. Do not change a part of the product without approval from the manufacturer. Only use parts that are approved by the manufacturer. Injury or death is a possible result of incorrect maintenance.
- Do not breathe in the exhaust fumes from the engine. A health risk can occur if you breathe in exhaust fumes, chain oil fumes and sawdust for a long period.
- Do not start the product indoors or near flammable material. The exhaust fumes are hot and can contain a spark which can start a fire. Without sufficient airflow, injury or death can result from asphyxiation or carbon monoxide.
- This product makes an electromagnetic field during operation. The electromagnetic field can cause damage to medical implants. Speak to your physician and medical implant manufacturer before you operate the product.
- Do not let a child operate the product.
- Do not let a person, without knowledge of the instructions, operate the product.
- Always monitor a person, with decreased physical capacity or mental capacity, that uses the product. A responsible adult must be there at all times.
- Lock the product in an area that children and not approved persons cannot access.
- The product can eject objects and cause injuries. Obey the safety instructions to decrease the risk of injury or death.
- Do not go away from the product when the engine is on. Stop the engine and make sure that the chain does not rotate.
- The operator of the product is responsible if an accident occurs.
- Make sure that parts are not damaged before you use the product.
- Refer to national or local laws. They can prevent or decrease the operation of the product in some conditions.

Safety instructions for operation

- Continuous or regular operation of the product can cause "white finger" or equivalent medical problems from vibrations. Examine the condition of your hands and fingers if you operate the product continuously or regularly. If your hands or fingers have discoloration, have pain, tingle, or are numb, stop work and speak to a physician immediately.
- Make sure the product is fully assembled before you use it.
- The product can cause objects to eject, which can cause damage to the eyes. Always use approved eye protection when you operate the product.
- Be careful, a child can come near the product without your knowledge during operation.
- Do not operate the product if there are persons in the work area. Stop the product if a person goes into the work area.

(Fig. 23)

- Make sure that you are always in control of the product.
- The product must be operated with two hands. Do not operate the product with one hand. Serious injury to the operator, workers, bystanders, or a combination of these persons may result from operation with only one hand.
- Hold the front handle with your left hand and the rear handle with your right hand. Hold the product on the right side of your body.

(Fig. 24)

- Do not operate the product when you are fatigued, ill or under the influence of alcohol or other drugs.
- Do not use the product if you cannot receive aid if an accident occurs. Make others aware that you will operate the product before you start the product.
- Do not turn with the product before you make sure that no persons or animals are in the safety area.
- Remove all unwanted materials from the work area before you start. If the chain hits an object, the object can eject and cause injury or damage. Unwanted material can wind around the chain and cause damage.
- Do not use the product in bad weather, such as fog, rain, strong winds, risk of lightning or other weather conditions. Dangerous conditions, such as slippery surfaces, can occur because of bad weather.
- Make sure that you can move freely and work in a stable position.
- Make sure that you cannot fall when you use the product. Do not tilt when you operate the product.
- Always hold the product with your two hands. Hold the front handle with your left hand and the rear handle with your right hand. Hold the product on the right side of your body.
- If the choke control is in the choke position when the engine starts, the chain starts to turn.
- Stop the engine before you move the product.

- Do not put down the product with the engine on.
- Before you remove the unwanted materials from the product, stop the engine. Let the chain stop before you or another person can remove the cut material.
- Do not operate this product in a tree. Operation of the product while up in a tree may result in personal injury.

(Fig. 25)

- The chain brake must be engaged when the product is started to decrease the risk that the saw chain touches you during start.

(Fig. 26)

- Avoid kickback, skating, bouncing and dropping, which can result in serious injury.
- Obey all safety rules to help avoid kickback and other forces which can result in serious injury.
- Adjust the saw chain tension regularly to make sure that the saw chain does not slack. A slack saw chain may jump off and cause serious injury or death.
- Do not fell trees using an incorrect procedure. This can cause injury to persons, hit a utility line or cause damage to property.
- The operator should remain on the uphill side of the terrain as the tree is likely to roll or slide downhill after it is felled.

(Fig. 27)

- Plan and clear an escape path before cuts are started. The escape path should extend back and diagonally to the rear of the expected line of fall.

(Fig. 28)

- Always stop the engine before you move the product between the trees.
- Make sure you firmly plant your feet on the ground and distribute your weight evenly.

(Fig. 29)

- Always keep proper footing and operate the product only when standing on fixed, secure and level surface. Slippery or unstable surfaces such as ladders may cause a loss of balance or control.

(Fig. 30)

Kickbacks, skating, bouncing and dropping

Different forces can have an effect on the safe control of the product.

- **Skating** is when the guide bar glides or moves quickly across the wood.
- **Bouncing** is when the guide bar lifts off the wood and touches it again and again.
- **Dropping** is when the product drops down after the cut is made. This can cause the moving chain to touch a part of the body or other objects, causing injury or damage.
- **Kickback** is when the end of the guide bar touches objects and moves rearward, up or suddenly forward. Kickback also occurs when the wood closes

in and pinches the saw chain during the cut. Loss of control can result if the product touches an object in wood.

(Fig. 31)

- **Rotational Kickback** can occur when the moving chain touches an object at the top of the guide bar. This can cause the chain to bury into the object and cause the chain to stop immediately. The result is a very fast, reverse reaction that moves the guide bar up and rearward in the direction of the operator.

(Fig. 32)

(Fig. 33)

- **Pinch-Kickback** can occur when the saw chain suddenly stops during the cut. The wood closes in and pinches the moving saw chain along the top of the guide bar. The sudden stop of the chain reverses the chain force and causes the product to move in the opposite direction of the turn of the chain. The product moves rearward in the direction of the operator.

(Fig. 34)

- **Pull-In** can occur when the saw chain suddenly stops when the moving chain touches an object in the wood along the bottom of the guide bar. The sudden stop pulls the product forward and away from the operator, which can easily cause the loss of control of the product by the operator.

(Fig. 35)

Make sure that you understand the different forces and how to prevent them before you operate the product.

To prevent kickbacks, skating, bouncing and dropping

- While the engine runs, make sure to hold the product tightly. Keep your right hand on the rear handle and the left hand on the front handle. Tightly hold with thumbs and fingers around the handles. Do not let go.
- Keep control of the product during the cut and after the wood falls to the ground. Do not let the weight of the product drop down after the cut is made. (Fig. 36)
- Make sure that the area in which you are cutting is free from blockage. Do not let the nose of the guide bar touch a log, branch or other blockages while you operate the product.
- Cut at high engine speeds.
- Do not overreach or cut above shoulder height. (Fig. 37)
- Obey the manufacturer's sharpening and maintenance instructions for the saw chain.
- Only use replacement guide bars and saw chains specified by the manufacturer.
- The risk of kickback is increased if the depth gauge setting is too large.

Personal protective equipment

- Always use the correct personal protective equipment when you operate the product. The personal protective equipment does not erase the risk of injury. The personal protective equipment decreases the grade of injury if an accident occurs.
- Generally, clothes should be close-fitting without restricting your freedom of movement.
- Use an approved protective helmet.
- Always use approved ear protection while you operate the product. Noise for a long period can cause hearing loss.
- Use protective glasses or a face visor to reduce the risk of injury from thrown objects. The product is capable of throwing objects, such as wood chips, small pieces of wood, etc., at great force. This can result in serious injury, especially to the eyes.
- Use gloves with chainsaw protection.
- Use trousers with chainsaw protection.
- Use boots with chainsaw protection, steel toe-cap and non-slip sole.
- Make sure that you have a first aid kit near.
- Sparks can come from the muffler, the guide bar and saw chain or other sources. Always have fire extinguishing tools and a shovel available to help prevent forest fires.

Protective devices on the product

- Make sure that you regularly do the maintenance to the product.
 - The life of the product increases.
 - The risk of accidents decreases.

Let an approved dealer or an approved service center regularly examine the product to do adjustments or repairs.

- Do not use a product with damaged protective equipment. If the product is damaged, speak to an approved service center.

Stop switch

Start the engine. Make sure that the engine stops when you move the stop switch to the stop position.

To examine the throttle trigger lockout

1. Make sure that the trigger (B) is locked at idle when you release the trigger lockout (A). (Fig. 38)
2. Push the trigger lockout (A) and make sure that it goes back to its initial position when you release it.
3. Push the trigger (B) and make sure that it goes back to its initial position when you release it.
4. Start the engine, and then apply full speed.
5. Release the trigger and examine if the saw chain stops.
6. If the saw chain turns with an idle engine, examine the idle adjustment screw of the carburetor.

Guard

The guard prevents objects from being ejected in the direction of the operator. The guard also prevents accidental touch between the operator and the saw chain.

- Make sure that the guard is permitted for operation in combination with the product.
- Do not use the product without the guard.
- Make sure that the guard is not damaged. Replace the guard if it is worn or has cracks.

Fuel safety

- Do not start the product if there is fuel or engine oil on the product. Remove the unwanted fuel/oil and let the product dry. Remove unwanted fuel from the product.
- If you spill fuel on your clothing, change clothing immediately.
- Do not get fuel on your body, it can cause injury. If you get fuel on your body, use a soap and water to remove the fuel.
- Do not start the engine if you spill oil or fuel on the product or on your body.
- Do not start the product if the engine has a leak. Examine the engine for leaks regularly.
- Be careful with fuel. Fuel is flammable and the fumes are explosive and can cause injuries or death.
- Do not breathe in the fuel fumes, it can cause injury. Make sure that there is a sufficient airflow.
- Do not smoke near the fuel or the engine.
- Do not put warm objects near the fuel or the engine.
- Do not add the fuel when the engine is on.
- Make sure that the engine is cool before you refuel.
- Before you refuel, open the fuel tank cap slowly and release the pressure carefully.
- Do not add fuel to the engine in an indoor area. Not sufficient airflow can cause injury or death because of asphyxiation or carbon monoxide.
- Tighten the fuel tank cap carefully or a fire can occur.
- Move the product at a minimum of 3 m (10 ft) from the position where you filled the tank before a start.
- Do not put too much fuel in the fuel tank.
- Make sure that a leak cannot occur when you move the product or fuel container.
- Do not put the product or a fuel container where there is an open flame, spark or pilot light. Make sure that the storage area does not contain an open flame.

- Only use approved containers when you move the fuel or put the fuel into storage.
- Empty the fuel tank before long-term storage. Obey the local law on where to dispose fuel.
- Clean the product before long-term storage.
- Remove the spark plug cable before you put the product into storage to make sure that the engine does not start accidentally.

Safety instructions for maintenance

- Disconnect the spark plug before doing maintenance on the product, not including carburetor adjustments.
- Have all product servicing done by an approved dealer, not including the tasks in *Maintenance on page 21*.
- Make sure the saw chain stops moving when the throttle trigger is released.
- Keep the handles dry, clean, and free from oil or fuel mixture.
- Keep caps and fasteners correctly tightened.
- Replacement components that are not approved or the removal of safety devices can cause damage to the product. This can also cause possible injury to the operator or bystanders. Only use accessories and replacement parts as recommended. Do not change your product.
- Keep the saw chain sharp and clean for safe and high performance.
- Obey the instructions for lubricating and changing accessories.
- Examine the product for damaged parts. Before more use of the product, make sure the damaged guard or part operates correctly. Examine for broken or incorrectly aligned parts, and parts that do not move freely. Examine for other conditions that can have an effect on the operation of the product. Make sure the product is correctly installed. A guard or other damaged part must be repaired or replaced by an approved dealer unless written in the operator's manual.
- When not in operation, keep the product in a dry, high or locked area away from children.
- During transportation or storage of the product, use a transportation guard or case to move the product.
- Do not use waste oil. Waste oil can be dangerous to you and can cause damage to the product and environment.

Assembly



WARNING: Read and understand the safety chapter before you assemble the product.

To assemble the guide bar and saw chain (standard chain adjustment)

1. Remove the spark plug cap from the spark plug during assembly to prevent an accidental start.
 2. Remove the bar nuts and the sprocket cover. Remove the transportation guard (A). (Fig. 39)
 3. Put the guide bar above the bar bolts. Steer the guide bar to its most rear position. (Fig. 40)
 4. Put on protective chainsaw gloves.
 5. Lift the saw chain above the drive sprocket and engage it in the groove on the guide bar. Start on the top edge of the guide bar. (Fig. 41)
 6. Make sure that the edges of the cutting links are turned forward on the top edge of the guide bar.
 7. Assemble the sprocket cover and steer the chain adjuster pin to the hole in the guide bar.
 8. Make sure that the drive links of the saw chain fit correctly on the drive sprocket. Also make sure that the saw chain is correctly engaged in the groove in the guide bar.
 9. Tighten the guide bar nuts with your fingers.
 10. Tighten the saw chain by turning the chain tensioning screw clockwise with the combination wrench (Fig. 42). Tighten the saw chain until it does not sag from below the guide bar, but you can turn it easily by hand. (Fig. 43)
 11. Hold up the end of the guide bar and tighten the bar nuts with the combination wrench. (Fig. 44)
 - Examine the chain tension frequently after you assemble a new saw chain and until the saw chain has been run-in.
 - Examine the chain tension regularly. Correct chain tension results in good cutting performance and a long life.
5. Put the guide bar over the bar bolts. Steer the guide bar to its most rear position. Put the chain over the drive sprocket and engage it in the groove on the guide bar. Start on the top edge of the guide bar. (Fig. 48)
 6. Make sure that the edges of the cutting links are turned forward on the top edge of the guide bar.
 7. Assemble the sprocket cover and steer the chain adjuster pin to the hole in the guide bar. Make sure that the drive links of the chain fit correctly on the drive sprocket. Also make sure that the saw chain is correctly engaged in the groove in the guide bar. (Fig. 49)
 8. Tighten the saw chain by turning the wheel down (+). Tighten the chain until it does not sag from below of the guide bar. (Fig. 50)
 9. The saw chain is correctly tightened as it does not sag from below the guide bar, but you can turn it easily by hand.
 10. Hold up the guide bar tip and turn the knob clockwise to tighten it. (Fig. 51)
 - Examine the chain tension frequently after you assemble a new saw chain and until the saw chain has been run-in.
 - Examine the chain tension regularly. Correct chain tension results in good cutting performance and a long life.

To assemble the guide bar and saw chain (knob and wheel chain adjustment)

1. Move the front hand guard in the direction of the front handle to disengage the chain brake.
2. Fold the knob out to open position. (Fig. 45)
3. Turn the knob counterclockwise to loosen the bar cover. (Fig. 46)
4. Remove the knob (A) and the sprocket cover. Remove the transportation guard, if installed. (Fig. 47)

To reset the chain brake

If the clutch cover is removed accidentally while the chain brake is locked, the chain brake must be unlocked so the clutch cover can be assembled without binding to the clutch drum.



CAUTION: The chain brake spring is under tension. Use care when resetting the chain brake.

Note: Do not hold the brake band while attempting to reset it.

1. Align the notches on the bar tool so that they fit over the brake rotating link. (Fig. 52)
2. To reset the brake, rotate the link clockwise until it stops. The front link will be in its downward rotated position when the chain brake is unlocked. (Fig. 53) (Fig. 54)

Operation



WARNING: Read and understand the safety chapter before you operate the product.

To use fuel



CAUTION: This product has a two-cycle engine. Use a mixture of gasoline and two-cycle engine oil. Make sure to use the correct quantity of oil in the mixture. Incorrect ratio of gasoline and oil can cause damage to the engine.

Fuel mixture ratio

The fuel mixture ratio for the gasoline and two-cycle engine oil is 50:1 (2%)

Gasoline	Two-cycle engine oil
1 U.S. Gal.	77 ml (2.6 oz)
1 UK Gal.	95 ml (3.2 oz)
5 l	100 ml (3.4 oz)

To make the fuel mixture

1. Determine the correct quantity of gasoline and engine oil (mixture ratio 50:1). Do not make more than 30 days quantity of fuel mixture. See *To use fuel on page 19*.
2. Add half of the gasoline quantity to a clean fuel container with an antispill valve.



CAUTION: Do not use gasoline with more than 10% ethanol concentration (E10). This can cause damage to the product.



CAUTION: Do not use gasoline with an octane number less than 90 RON (87 AKI). This can cause damage to the product.

Note: Use gasoline with a higher octane number if you frequently use the product at continuously high engine speed.

3. Add the full quantity of the two-cycle engine oil to the fuel container.



CAUTION: Always use air-cooled two-cycled engine oil of high quality. Other oils can cause damage to the product.

4. Shake the fuel mixture to mix the contents.
5. Add the remaining gasoline quantity to the fuel container.
6. Shake the fuel mixture to mix the contents.
7. Fill the fuel tank of the product with the fuel mixture. See *To use fuel on page 19*.

To fill the fuel tank

1. Make sure that the fuel mixture is correct and that the fuel mixture is in a fuel container with an antispill valve.
2. If fuel is on the container, remove the unwanted fuel and let the container dry.
3. Make sure that the area near the fuel tank cap is clean.
4. Remove the fuel tank cap.
5. Shake the fuel container before you add the fuel mixture to the fuel tank.
6. Put back the fuel tank cap.

To lubricate the saw chain

The product has an automatic lubrication system. The saw chain oil tank and the fuel tank are designed so that the fuel runs out before the saw chain oil. This safety feature requires that the correct chain oil is used and that the instructions are obeyed.

1. Use vegetable-based saw chain oil or a standard chain oil.
2. Make sure that the area near the cap of the saw chain oil tank is clean.
3. Remove the cap of the saw chain oil tank.
4. Fill the saw chain oil tank with the recommended saw chain oil.
5. Put back the cap of the saw chain oil tank.

To start and stop

Before you start the engine

- Examine the product for missing, damaged, loose or worn parts.
- Examine the nuts, screws and bolts.
- Examine the air filter.
- Examine the trigger lockout and the trigger for correct operation.
- Examine the stop switch for correct operation.
- Examine the product for fuel leaks.
- Examine the saw chain sharpness and tension.

To start a cold engine

1. Move the front hand guard forward to engage the chain brake. (Fig. 55)
2. Pull the choke control out fully. (Fig. 56)
3. Push the air purge bulb 6 times. (Fig. 57)
4. Hold the body of the product on the ground with your left hand.
5. Put your right foot through the rear handle.
6. Pull the starter rope handle slowly with your right hand until you feel some resistance.
7. Pull the starter rope handle with force. (Fig. 58)



CAUTION: Do not pull the starter rope until it stops. Do not let go of the starter rope when it is fully extended. Release the starter rope slowly. If you do not obey these instructions, it can cause damage to the engine.

Note: Do not pull the throttle trigger when you start the engine.

- Continue to pull the starter rope handle until the engine starts or tries to start (pull max 5 times).
- If the engine starts or tries to start, push the choke control in to the half choke position. (Fig. 59)
- Continue to pull until the engine starts.
- Hold the rear handle with your right hand and the front handle with your left hand. (Fig. 60)
- Immediately pull the front hand guard rearward in the direction of the front handle to disengage the chain brake. (Fig. 61)

Note: The chain will move.

- Run 20-30 seconds at elevated idle speed.
- Pull the throttle trigger slowly but fully for 8-10 seconds, then release. (Fig. 62)
- Run 10 seconds at normal idle speed.
- Pull the throttle trigger slowly but fully for 5 seconds to check acceleration, then release.
- Use the product.

To start a warm engine

- Move the front hand guard forward to engage the chain brake.
- Pull the choke control out fully.
- Push the air purge bulb 6 times.
- Push the choke control in fully.
- Hold the body of the product on the ground with your left hand.
- Put your right foot through the rear handle.
- Pull the starter rope handle slowly with your right hand until you feel some resistance.
- Pull the starter rope handle with force.



CAUTION: Do not pull the starter rope until it stops. Do not let go of the starter rope when it is fully extended. Release the starter rope slowly. If you do not obey these instructions, it can cause damage to the engine.

Note: Do not pull the throttle trigger when you start the engine.

- Pull the starter rope handle until the engine starts.

- Hold the rear handle with your right hand and the front handle with your left hand.
- Immediately pull the front hand guard rearward in the direction of the front handle to disengage the chain brake.



Note: The chain will move.

- Wait 10-15 seconds.
- Pull the throttle trigger lightly to set normal idle.
- Use the product.

To start the engine when the fuel is too hot

If the product does not start, the fuel can be too hot.

Note: Always use new fuel and decrease the operation time during warm weather.

- Put the product in a cool area away from open sunlight.
- Let the product cool down for 20 minutes at minimum.
- Press the air purge bulb again and again for 10-15 seconds.
- Obey the procedure to start a cold engine. Refer to *To start a cold engine on page 19*.

To stop the engine

- Push the stop switch to stop the engine.

Note: The stop switch automatically goes back to its initial position.

To fell a tree

- Remove dirt, stones, loose bark, nails, staples and wire from the tree.
- Make a notch 1/3 the diameter of the tree, perpendicular to the direction of the fall. (Fig. 63)
- Make the lower horizontal notch cut. This will prevent either the saw chain or the guide bar from being pinched when the second notch is made.
- Make the felling back cut (X) at least 50 mm (2 in) higher than the horizontal notching cut. Keep the felling back cut parallel to the horizontal notching cut so enough wood is left to act as a hinge. Do not cut through the hinge. The hinge wood keeps the tree from twisting and falling in the wrong direction. (Fig. 64) (Fig. 65)
- As the felling back cut nears the hinge, the tree starts to fall. Make sure that the tree can fall in the correct direction and not rock rearward and pinch the saw chain. Stop the cut before the felling back cut is complete to prevent this. Use wedges of wood, plastic or aluminium to open the cut and let the tree fall along the necessary line of fall. (Fig. 66)

- When the tree begins to fall, remove the product from the cut, stop the engine, put the product down, then use the retreat path planned. Be alert for overhead limbs falling and watch your footing. (Fig. 67)

To limb a tree

- Use larger limbs to hold the log off the ground.
- Remove small limbs in one cut. (Fig. 68)
- Cut branches that have tension from the bottom to the top to prevent pinching the saw chain or the guide bar.

To buck a log



CAUTION: Do not let the saw chain touch the ground.

- If the log is supported along its entire length, cut from the top of the log (known as overbucking). (Fig. 69)
- If the log is supported on one end, cut 1/3 the diameter from the underside of the log (known as underbucking). (Fig. 70)
- If the log is supported on both ends, cut 1/3 the diameter from the top. Complete the cut by underbucking the lower 2/3 of the log to meet the first cut. (Fig. 71)
- If you buck a log on a slope, always stand on the uphill side of the log. Cut through the log while you maintain complete control of the product, then release the cutting pressure near the end of the cut while firmly gripping the rear handle and front handle. (Fig. 72)

Maintenance



WARNING: Read and understand the safety chapter before you clean, repair or do maintenance on the product.

Maintenance schedule

Make sure that you obey the maintenance schedule. The intervals are calculated from daily use of the product. The intervals are different if you do not use the product each day. Only do the maintenance work that is found in this manual. Speak to an approved service center about other maintenance work not found in this manual.

Daily maintenance

- Clean the external surfaces.
- Make sure that the lockout and trigger work correctly.
- Clean the chain brake and make sure that it works correctly. (Fig. 73)
- Examine the chain catcher for damage. Replace the chain catcher if it is damaged. (Fig. 74)
- Turn the guide bar daily for more even wear.
- Make sure that the lubrication hole in the guide bar is not clogged. (Fig. 75)
- Clean the guide bar groove. (Fig. 76)
- Make sure that the guide bar and saw chain get sufficient oil.
- Examine the saw chain:
 - for cracks in the rivets and links.

- for abnormally worn rivets and links.
 - for correct tension.
- If necessary, replace the saw chain.
- Sharpen the saw chain. See *To sharpen the saw chain on page 22*.
 - Examine the drive sprocket for excessive wear and replace if necessary. (Fig. 77)
 - Clean the air intake of the starter unit.
 - Make sure that the nuts and screws are tight.
 - Make sure that the stop switch works correctly.
 - Examine the engine, tank and fuel lines for fuel leaks.
 - Make sure that the saw chain does not rotate when the engine is idling.

Weekly maintenance

- Make sure that the cooling system works correctly.
- Make sure that the starter, starter cord and return spring work correctly.
- Make sure that the vibration damping elements are not damaged. (Fig. 78)
- File off any burrs from the edges of the guide bar.
- Clean or replace the spark arrestor screen on the muffler. (Fig. 79)
- Clean the external surfaces of the carburetor and its adjacent areas.
- Clean the air filter. Install a new air filter if it is damaged or too dirty to be fully cleaned. See *To clean the air filter on page 22* for more information.

Monthly maintenance

- Examine the brake band on the chain brake for wear. Replace when the brake band thickness is less than 0.6 mm (0.024 in) at the most worn point.

(Fig. 80)

- Examine the clutch center, clutch drum and clutch spring for wear.
- Clean the spark plug. Make sure that the electrode gap is correct.

(Fig. 81)

- Clean the external surfaces of the carburetor and its adjacent areas.
- Examine the fuel filter and the fuel hose. Replace if necessary.
- Empty the fuel tank.
- Empty the oil tank.
- Examine all cables and connections.

Yearly maintenance

- Examine the spark plug.
- Clean the external surfaces of the carburetor and its adjacent areas.
- Clean the cooling system.
- Examine the spark arrester mesh.
- Examine the fuel filter.
- Examine the fuel hose for damage.
- Examine all cables and connections.

Intermittent maintenance

- Have an approved service center repair or replace the muffler after 50 hours of operation.
- Do maintenance on the spark plug when:
 - the power level in the engine is low.
 - it is hard to start the engine.
 - the engine does not work correctly at idle speed.
- Do a check of the saw chain lubrication each time you refuel. See *To do a check of the saw chain lubrication on page 24*.

To adjust the idle speed

Make sure that the air filter is clean and the air filter cover is attached before you adjust the idle speed.

1. Turn the idle adjustment screw, which is identified with a "T" mark, clockwise until the saw chain starts to turn.
2. Turn the idle adjustment screw, which is identified with a "T" mark, counterclockwise until the saw chain stops.
3. The idle speed must be below the speed when the saw chain starts to turn. The idle speed is correct when the engine operates smoothly in all positions.

To clean the spark arrester screen

1. Use a wire brush to clean the spark arrester screen.

To do maintenance on the spark plug



CAUTION: Use the recommended spark plug. Make sure that the replacement is the same as the manufacturer supplied part. An incorrect spark plug can cause damage to the product.

1. If the product is hard to start or operate, examine the spark plug for unwanted materials. To decrease the risk of unwanted material on the spark plug electrodes:
 - a) make sure that the idle speed is correctly adjusted.
 - b) make sure that the fuel mixture is correct.
 - c) make sure that the air filter is clean.
2. Clean the spark plug if it is dirty. Make sure that the electrode gap is correct. (Fig. 81)
3. Replace the spark plug when it is necessary.

To clean the air filter

1. Remove the air filter cover and remove the air filter.
2. Clean the air filter with warm soap water. Make sure that the air filter is dry before you install it.
3. Replace the air filter if it is too dirty to fully clean it. Always replace a damaged air filter.

To sharpen the saw chain

The cutter

The cutting part of the saw chain is called the cutter and consists of a cutting tooth (A) and the depth gauge (B). The cutters cutting depth is determined by the difference in height between the two, the depth gauge setting (C).

(Fig. 82)

When you sharpen a cutting tooth there are four important factors to remember:

- Filing angle.

(Fig. 83)

- Cutting angle.

(Fig. 84)

- File position.

(Fig. 85)

- Round file diameter.

(Fig. 86)

To sharpen the cutting teeth

Use a round file and a file gauge to sharpen the cutting teeth. See *Saw chain filing and saw chain combinations on page 23* for information on the recommended

dimension of the file and gauge for the saw chain installed on your product.

1. Make sure that the saw chain is correctly tensioned. A slack chain will move sideways, making it more difficult to sharpen correctly.
2. File all teeth on one side first. File the cutting teeth from the inside face and reduce the pressure on the return stroke.
3. Turn the product over and file the teeth on the other side.
4. File all the teeth to the same length. When the length of the cutting teeth is reduced to 4 mm (5/32") the saw chain is worn out and must be replaced. (Fig. 87)

To adjust the depth gauge setting

Sharpen the cutting teeth before you adjust the depth gauge setting. See *To sharpen the cutting teeth on page 22*. When you sharpen the cutting tooth (A), the depth gauge setting (C) will decrease. To maintain optimal cutting performance, the depth gauge (B) has to be filed down to achieve the recommended depth gauge setting. See *Saw chain filing and saw chain combinations on page 23* to find the correct depth gauge setting for your particular chain.

(Fig. 88)
(Fig. 89)

Note: This recommendation assumes that the length of the cutting teeth is not reduced excessively.

Use a flat file and depth gauge tool to adjust the depth gauge.

1. Put the depth gauge tool above the saw chain. Detailed information regarding how to use the depth gauge tool will be found on the package of the depth gauge tool.
2. Use the flat file to file off the tip of the depth gauge that protrudes through the depth gauge tool. The depth gauge setting is correct when you no longer feel resistance as you draw the file along the depth gauge tool.

Saw chain filing and saw chain combinations

Saw chain					
Chain type	Round file size	Side plate angle	Top plate angle	File guide angle	Depth gauge setting
H30	3/16 in. / 4,8 mm	60°	30°	10°	0,025 in. / 0,65 mm
H37	5/32 in. / 4,0 mm	60°	30°	0°	0,025 in. / 0,65 mm

To tension the saw chain (standard chain adjustment)

Note: Check the tension of a new saw chain frequently during its running-in period.

1. Loosen the guide bar nuts that hold the clutch cover. Use the combination wrench. (Fig. 90)
2. Tighten the guide bar nuts by hand as tight as you can.
3. Lift the top of the guide bar and extend the saw chain by tightening the chain tensioning screw. Use the combination wrench. Tighten the saw chain until it does not hang down from the bottom of the guide bar. (Fig. 91)
4. Tighten the guide bar nuts using the combination wrench and lift the tip of the guide bar at the same time. (Fig. 92)
5. Make sure that you can pull the saw chain round freely by hand and that it does not sag. (Fig. 93)

To tension the saw chain (knob and wheel chain adjustment)

Note: Examine the tension of a new saw chain frequently during its running-in period.

1. Release the knob by folding it out. (Fig. 94)
2. Turn the knob counterclockwise to loosen the guide-bar cover. (Fig. 95)
3. Adjust the tension on the chain by turning the chain tensioner wheel down (+) for tighter tension and up (-) to loosen the tension. Hold the tip of the guide bar while you adjust the tension. (Fig. 96)
4. Tighten the sprocket cover by turning the knob clockwise while lifting the tip of the guide bar. (Fig. 97)
5. Fold the knob in to lock the saw chain. (Fig. 98)
6. Make sure that you can pull the saw chain round freely by hand and that it does not sag. (Fig. 93)

To lubricate the cutting equipment

To do a check of the saw chain lubrication

Do a check of the chain saw lubrication each time you refuel.

1. Start the product and let it run at 3/4 speed. Point the nose of the guide bar at a light color surface almost 20 cm (8 in) away.
2. After 1 minute of running, a line of oil shows on the light surface.
3. If you cannot see the line of oil after 1 minute, clean the oil channel in the guide bar. Clean the groove in the edge of the guide bar. Make sure the guide bar nose sprocket turns freely and that there are no blockages in the lubrication hole. Clean and lubricate the tip sprocket.
4. Start the product and let it run at 3/4 speed. Point the nose of the bar at a light color surface almost 20 cm (8 in) away.
5. After 1 minute of running, a line of oil shows on the light surface.
6. If you cannot see the line of oil after 1 minute, speak to your approved dealer.

Transportation

- Put the transportation guard on the cutting attachment during transportation to prevent injuries.
- Make sure that the product can not move during transportation.

Storage

- Always put the product away safely when not in operation. Leakages and fumes from the product can touch sparks, naked flames from electrical equipment, electrical mowers, relays/switches, boilers and more.
- Always save fuel in an approved container.
- Empty the fuel tank and the chain oil tank when the product is in storage for longer periods of time. Discard used fluids correctly.
- Put the transportation guard on the cutting attachment during storage to prevent injuries.
- Remove the spark plug cap from the spark plug and engage the chain brake before storage.

Technical data

	unit	120e Mark II (P02138HV)
Engine specifications		
Cylinder displacement	cm ³	38
Spark plug		Champion RCJ7Y
Electrode gap	mm (in)	0,5 (0.02)
Fuel tank volume	cm ³	300
Idle speed	min ⁻¹	2800-3200
Power output at 9000 min ⁻¹	kW	1,4
Emission durability period	h	125
Noise and vibration data		
Equivalent vibration levels, a_{hveq} front handle ¹	m/s ²	5,3

¹ Equivalent vibration level, according to ISO 22867, is calculated as the time-weighted energy total for vibration levels under various working conditions. Reported data for equivalent vibration level has a typical statistical dispersion (standard deviation) of 1 m/s².

	unit	120e Mark II (P02138HV)
Equivalent vibration levels, a_{hveq} rear handle ²	m/s ²	6,7
Sound power level, guaranteed (L_{WA}) ³	dB(A)	116
Sound power level, measured ⁴	dB(A)	113
Sound pressure level at operator's ear ⁵	dB(A)	100
Product dimensions		
Weight (excluding cutting equipment)	kg (lb)	5,0 (11,0)
Oil tank volume	cm ³	200
Fuel and lubrication system		
Oil pump capacity at 9000 min ⁻¹	ml/min	7
Type of oil pump		Automatic
Saw chain and guide bar		
Standard guide bar length	cm (in)	35-40 (14-16)
Recommended bar lengths	cm (in)	33-46 (13-18)
Usable cutting length	cm (in)	29-43 (11-17)
Maximum saw chain speed	m/s	26,1
Saw chain pitch	mm (in)	8,3 (0.325) 9,52 (3/8)
Thickness of drive links (gauge)	mm (in)	1,3 (0.05)
Type of drive sprocket		0,325 and 3/8
Number of drive sprocket teeth		6 (drive sprocket 3/8), 7 (drive sprocket 0,325)

Accessories

Guide bar and saw chain combinations

The cutting attachments below are approved for the product.

² Equivalent vibration level, according to ISO 22867, is calculated as the time-weighted energy total for vibration levels under various working conditions. Reported data for equivalent vibration level has a typical statistical dispersion (standard deviation) of 1 m/s².

³ Noise emissions in the environment measured as sound power (L_{WA}).

⁴ Noise emissions in the environment measured as sound power (L_{WA}).

⁵ Equivalent sound pressure level is calculated as the time-weighted energy total for different sound pressure levels under various working conditions. Typical statistical dispersion for equivalent sound pressure level is a standard deviation of 1 dB(A).

Guide bar				Saw chain	
Length, cm (in)	Pitch, mm (in)	Gauge, mm (in)	Max. nose radius	Type	Drive link count
33 (13)	8,25 (0,325)	1,3 (0,050)	10T	Husqvarna H30	56
38 (15)	8,25 (0,325)				64
35 (14)	9,52 (3/8)		7T	Husqvarna S93G	52
40 (16)	9,52 (3/8)				56
45 (18)	9,52 (3/8)				62

Saw chain filing and saw chain combinations

Saw chain					
Chain type	Round file size	Side plate angle	Top plate angle	File guide angle	Depth gauge setting
H30	3/16 in. / 4,8 mm	60°	30°	10°	0,025 in. / 0,65 mm
S93G	5/32 in. / 4,0 mm	60°	30°	0°	0,025 in. / 0,65 mm



www.husqvarna.com

Original instructions

1141200-26



2020-05-20